

# zecomex

One-stop EV Charging  
Solution Provider



## ZECONEX LTD

📍 Building A, Hankun Hi-tech Industrial Zone, Longteng Road,  
Pingdi, Longgang District, Shenzhen, China

☎ + 86-755-84615006

✉ sales@zecomex.com

🌐 www.zecomex.com

# ABOUT US



**Zeconex** is the leading manufacturer of electric vehicle charging systems in the global market, headquartered in Shenzhen, China.

Our product portfolio consists of Portable Charger, AC Charger, DC Charger, Power Module and Cloud Management System and Mobile APP, all independently developed by ourselves. We exported to more than 30 countries and regions since 2012.



With over thousands of charging systems sold worldwide, Zeconex's DC Fast Chargers and AC Chargers serve Charge Point Operators, Oil & Gas, Convenient Stores, Retail Centers, Fleets and more for charging electric vehicles, heavy duty transit shuttle and school buses, fleets, and other specialty vehicles.



Our top R&D team both in China and abroad, with rich experience in international protocol (OCPP 1.6 above) , which support us to offer OEM/ODM service for our clients all over the world.

**Welcome to be our partners.**

## Why Choose Us



### 10+ years Expert

More than 10+ years Leading Manufacture in EV Charging Industry.



### Quality Control

Zeconex only focus on the best quality ev charging products to make sure our business partners relieved and long time working with us.

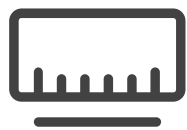

### Production Capacity

We own and share 3 factories more than 300 employees and over 20,000 square meters area,each factory focus on different products line.



### Strong R&D

We keep on innovation and products developing all days to meet the edge-leading demand of the market. We are good at learning from your suggestion to make the most perfect product.



### Lead Time

We have the ability to do large material stock for our standards products to ensure your fast lead time request.



### OEM/ODM Customization

Our top R&D team both in China and abroad, with rich experience in international protoco, which support us to offer OEM/ODM service for our clients all over the world.

## Production Center



# Our solutions for home use

## Dynamic Load Balance

Dynamic Load Balance is a smart charging feature which balances the distribution of the total available power between chargers and other loads within the building in real time. It not only protects appliances, but also ensures EVs are fully charged at the lowest cost.

CT box monitors the total energy consumption and reports to the management system. The system controls the charging power of each individual charger automatically to avoid overloading when chargers and other loads are being used simultaneously.

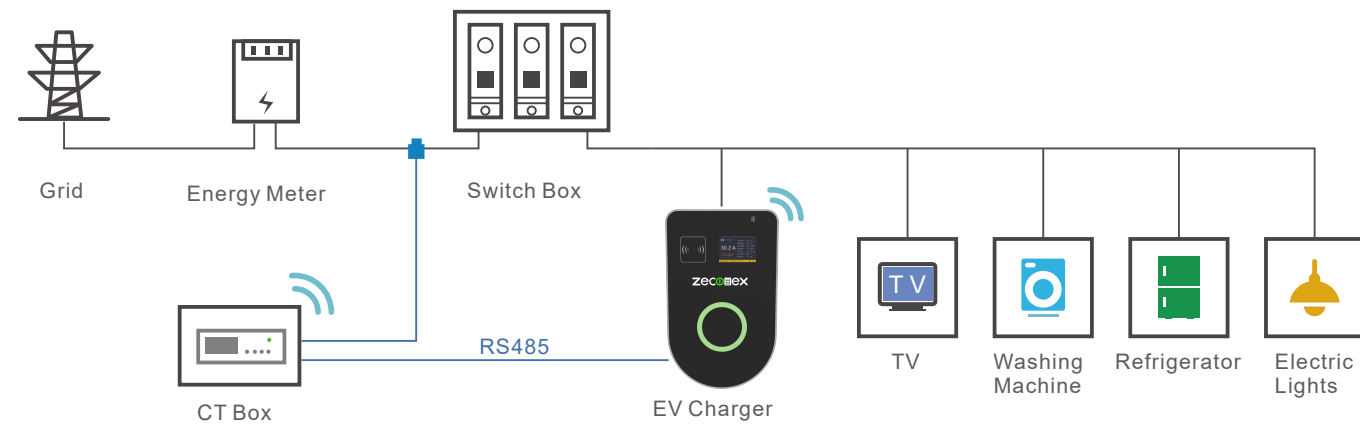

## Static Load Balance

Static Load Balance is a smart charging feature which balances the distribution of the total available power for multiple chargers at a specific location. It enables you to set a maximum power for multiple chargers in the management system and distribute the charging power evenly between the individual active chargers.

Load balance helps you to protect the local grid within the capacity limit in peak hours of electricity consumption. EVs can charge with maximum power when possible, but the charging power will drop as more EVs begin to be charged simultaneously. For example, the parking lot has a maximum of 32A available. When the first EV charges, it charges at 32A – the maximum capacity. When more EVs start charging, the charging capacity will be distributed evenly over the EVs

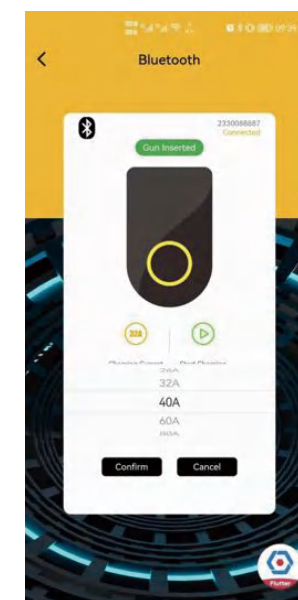
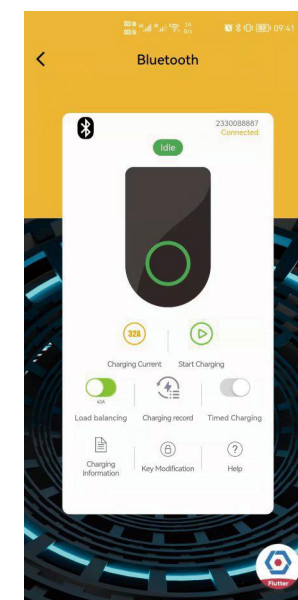
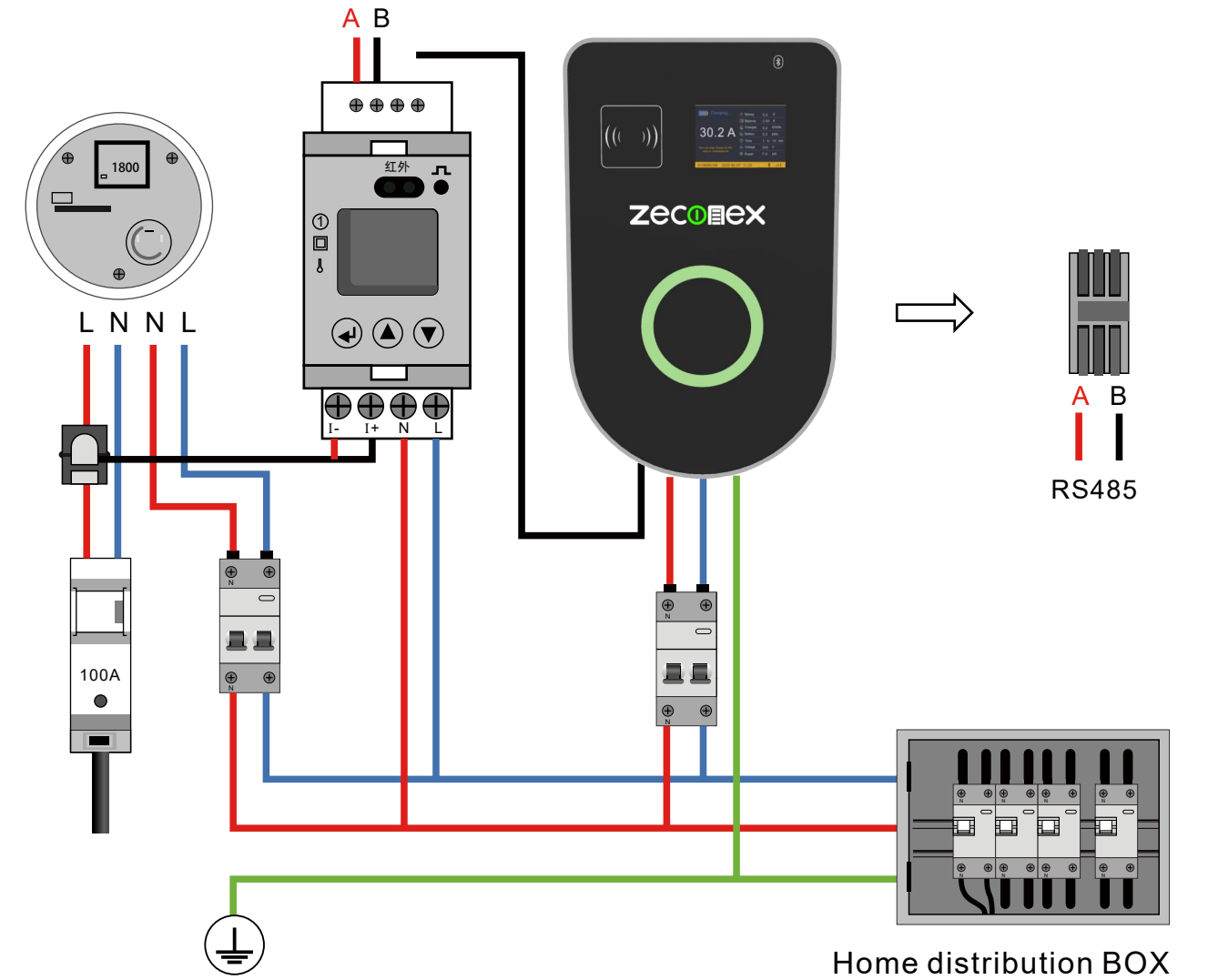
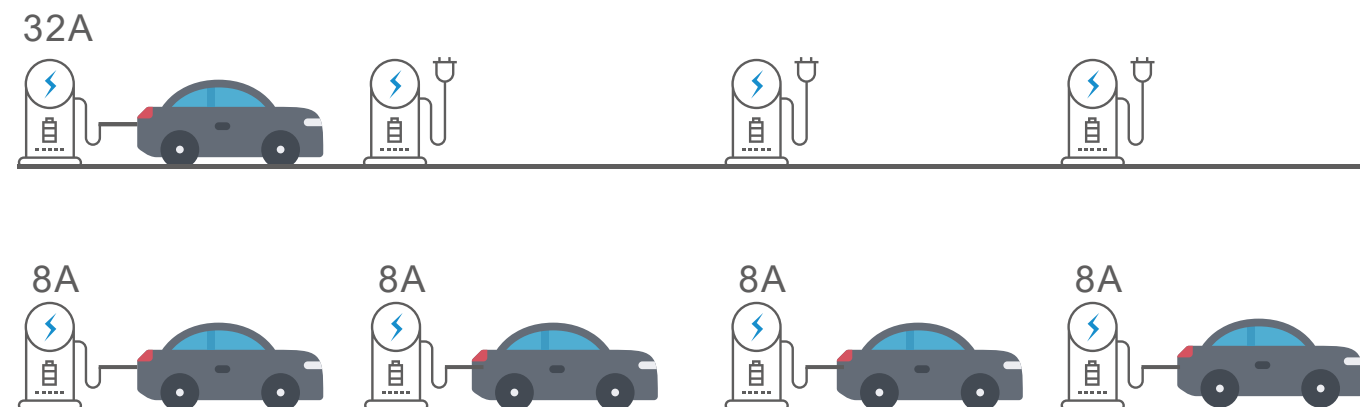

# Our solutions for public

We provide everything that's needed to build a charging business, from charging facilities to customer services and smart energy management solutions. You can either manage your own network of charging stations or provide the service for other charger operators. All solutions are white-labelled and can be customized to meet your customers' needs

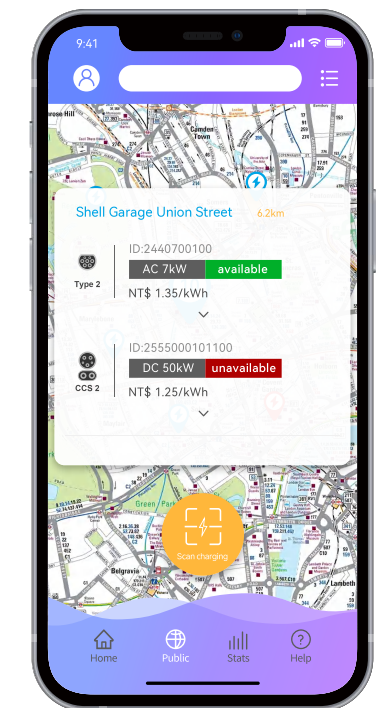
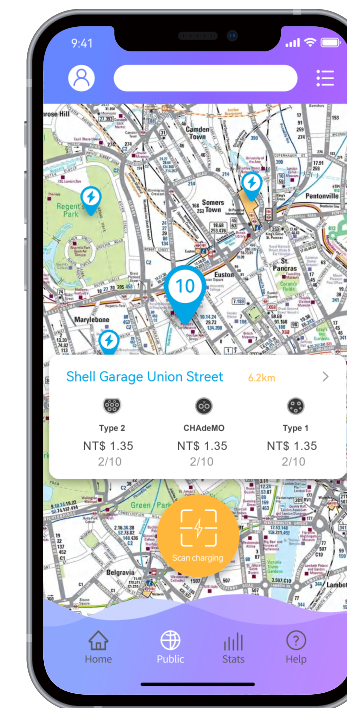
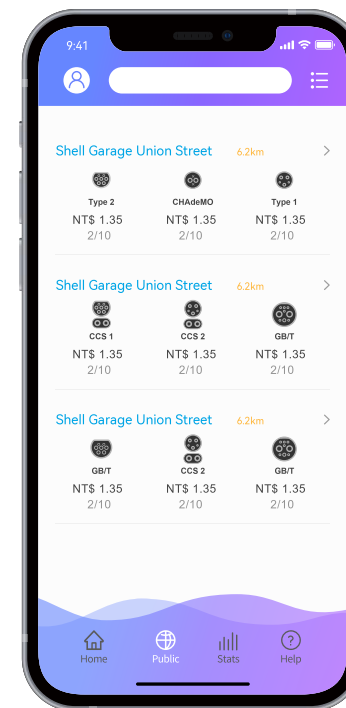
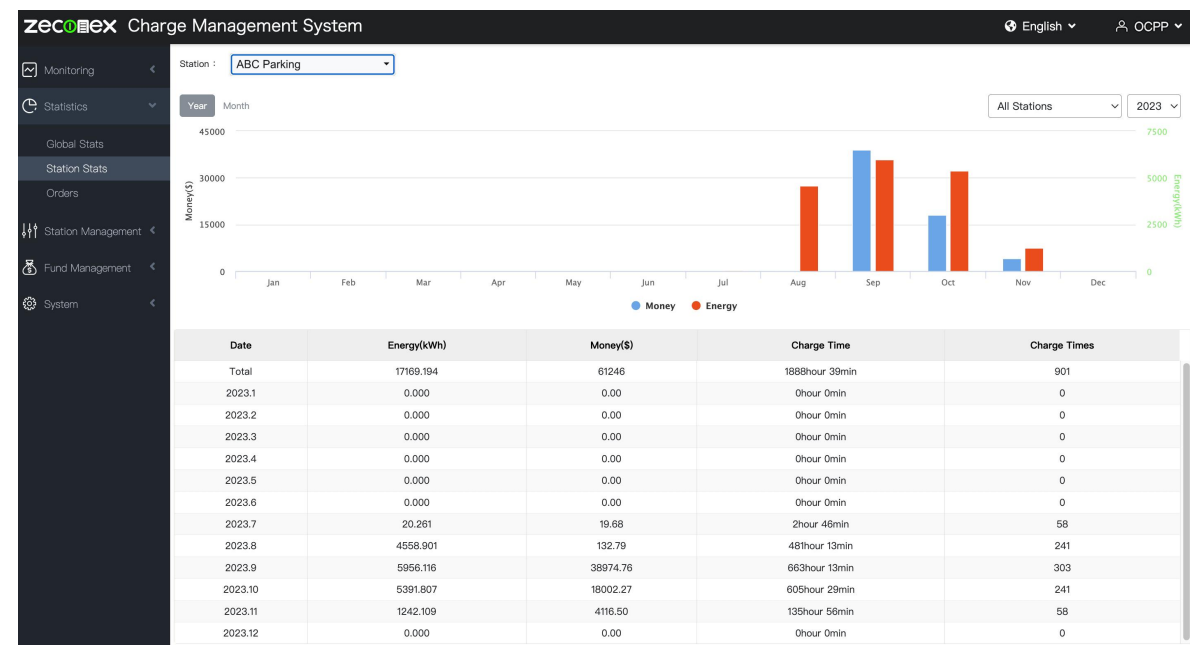
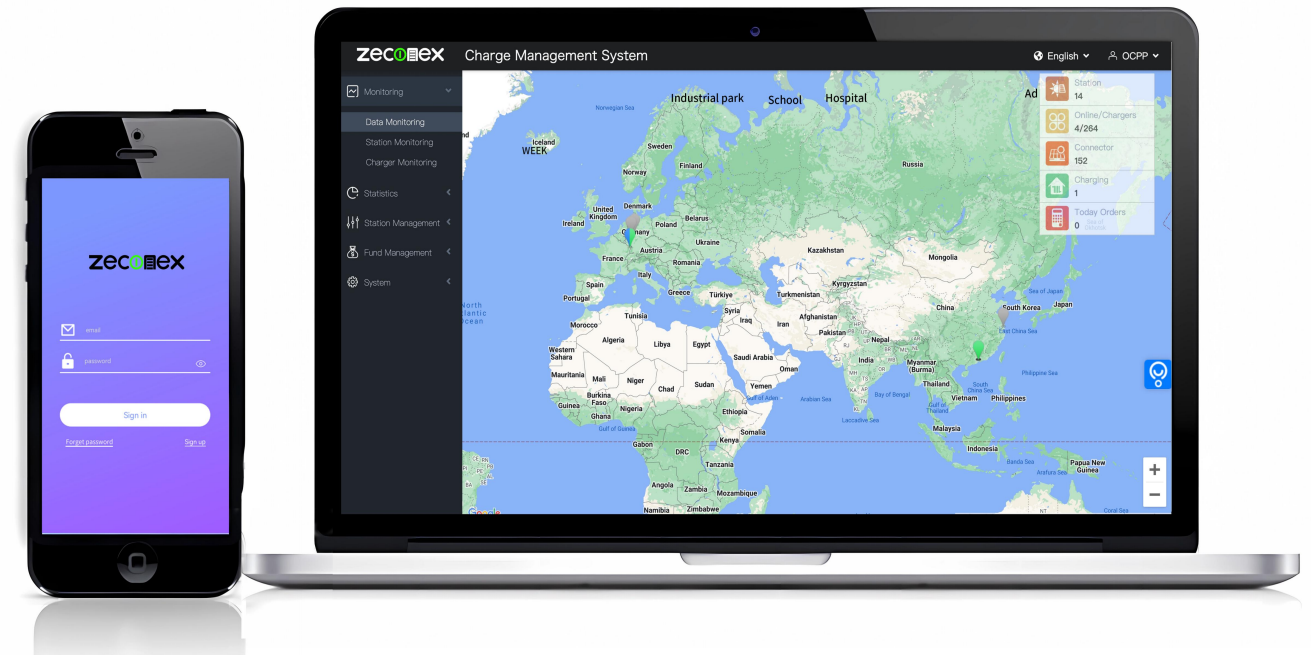
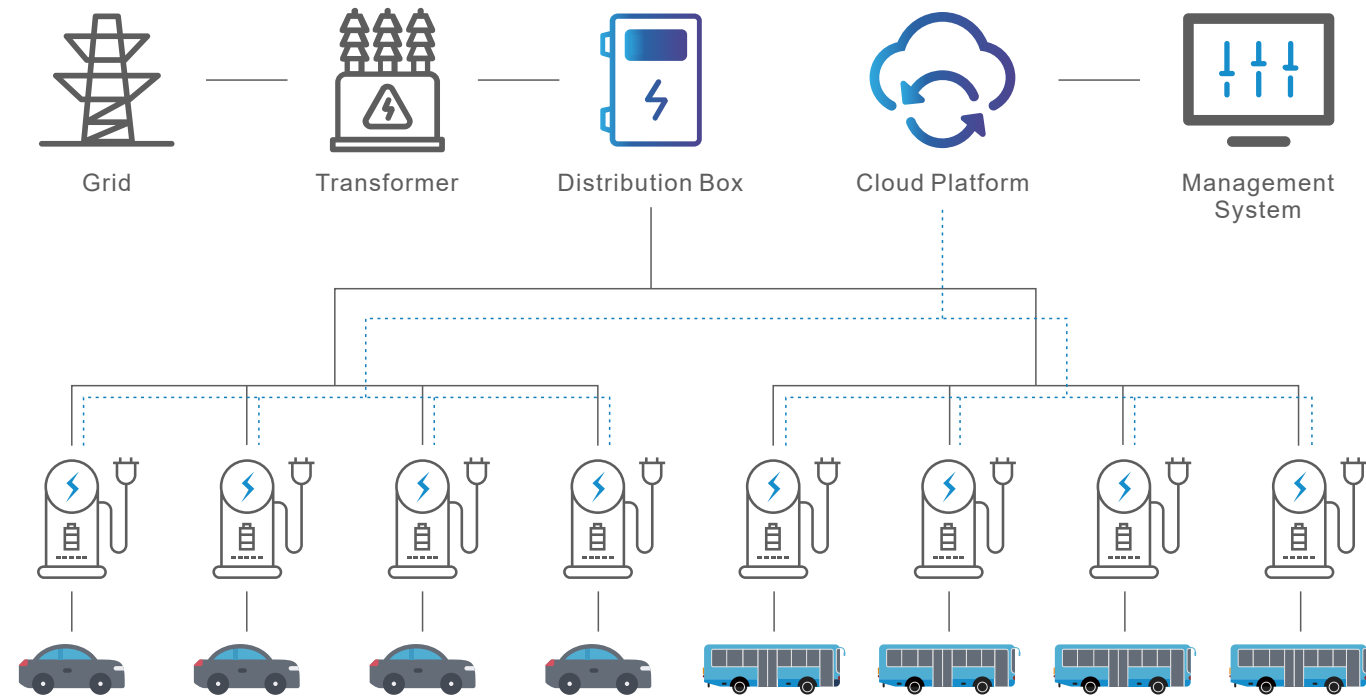

# Project Cases

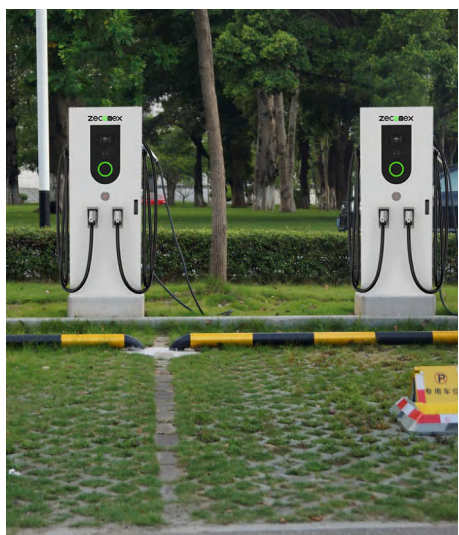
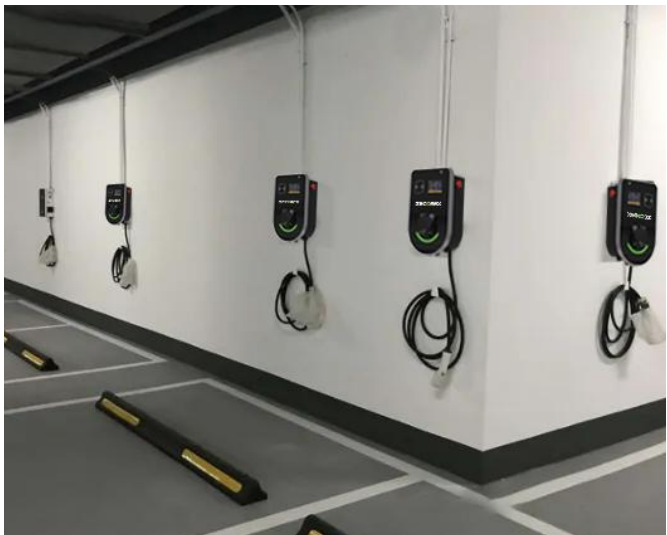

# Portable EV Box

## Secure and Safe

Type A+DC 6mA leakage protection  
Over temperature protection  
High protection grade up to IP65

## Friendly Interface

OLED Display  
Current can 8A, 10A, 13A, 16A, 20A, 32A, adjustable

## High compatibility

Fully compatible with all ev in the market

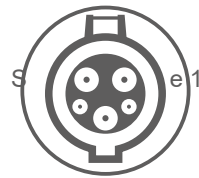

AE1772 Typ

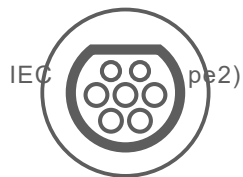

62196-2(Ty)



Schuko Plug



NEMA6-20P Plug



NEMA Plug



Blue CEE

Model	ZECO035K-P035	ZECO7K-P7
<b>Technical features</b>		
Charging capacity	Up to 3.5KW	Up to 7KW
Input/Output power	230VAC±20%, 50/60Hz, 8A-10A-13A-16A adjustable, 1-phase	230VAC±20%, 50/60Hz, 8A-16A-20A-32A adjustable, 1-phase
RCD	30Ma RCD Type A and DC 6Ma RCD function	
Standby power	<2W	
Measuring accuracy	1%	
User interface	LED , OLED , Select button	
Certificate/Compliance	CE/IEC61851-1,IEC61851-22,SAEJ1772	
Charging Interface	5M cable, Type2 Plug	
Power Cord Plug	Schuko/NEMA6-20P	NEMA14-50/Blue CEE
<b>Physical properties</b>		
Protection	IP65,IK10,	
Special Protection	Temperature sensor and plug a dapter	
Cooling	Natural cooling	
Operating temperature	-30°Cto+55°C	
Humidity	Max.95%(non-regulating)	
Product Dimensions	210*88*50(L*W*H)mm	
Package Dimension	350*320*60(L*W*H)mm	
Net Weight	2.02Kg	2.5Kg
Gross Weight	2.25Kg	2.7Kg

# Home EV Wallbox with cable & socket

## Secure and Safe

The best charging station for home and private use  
Type A+DC 6mA leakage protection

## Simple and intelligent

Home use app with intelligent bluetooth control the wallbox  
Dynamic Load Balance

## Flexible Option

Type 1 or Type 2 charging cable  
Wall-mount or floor-stand installation

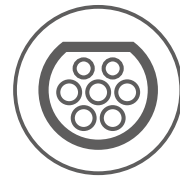

IEC62196-2 (Type 2)

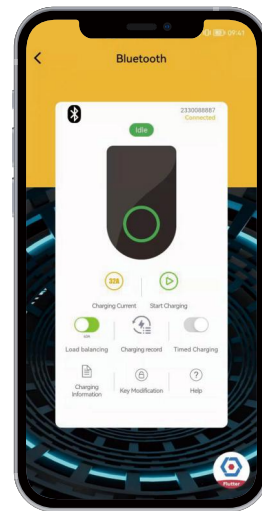

Model	ZECO7K-Y1	ZECO11K-Y2	ZECO22K-Y3
<b>Technical features</b>			
Charging capacity	Up to 7KW	Up to 11 KW	Up to 22KW
Input/Output power	230VAC±20%-50/60Hz-32A-1phase	400VAC±20%-50/60Hz-16A-3phase	400VAC±20%-50/60Hz-32A-3phase
RCD	30Ma RCD Type A and DC 6Ma RCD function		
Standby power	<3W		
Measuring accuracy	1%		
Communication	Bluetooth/WIFI(Optional) APP		
Load balancing	CT+Meter (Optional))		
PEN Protection	Optional		
User interface	LED/LCD(3.5")/ RFID(mifare iso& IEC 14443A)		
Certificate/Compliance	CE / EN/IEC 61851-1:2017, EN/IEC 61851-21-2:2018		
Charging Interface	Type 2 cable 5M	Type 2 cable 5M	Type 2 cable 5M
Special Protection	Over current protection, Residual current protection, Ground protection, Surge protection, Over/Under voltage protection, Over/Under frequency protection, Over/Under temperature protection		
<b>Physical properties</b>			
Warranty	2 years		
Protection	IP54, IK10,		
Enclosure	Plastic PC940/ Galvanized steel		
Front Panel	Temper glass		
Installation	Wall-mount/Pole-mount		
Cooling	Natural cooling		
Operating temperature	-30°C to +55°C		
Humidity	Max.95%(non-regulating)		
Product Dimensions	320*230*100(L*W*H)mm		
Package Dimension	465*325*270(L*W*H)mm		
Net Weight	5.1kg	5.5Kg	5.5Kg
Gross Weight	5.8kg	6.2Kg	6.5Kg



# Public EV Wallbox with cable & socket

## Safe and Fast

OCPP(1.6 above)communication protocol with CMS  
Wireless communication Wi-Fi/Ethernet/4G optional

## Simple and intelligent

MID certified energy meter with accurate measurement  
Type A+DC 6mA leakage protection

## Flexible Option

Universal Type 2 socket, optional with Type 1/Type 2 charging cable  
Wall-mount or floor-stand installation

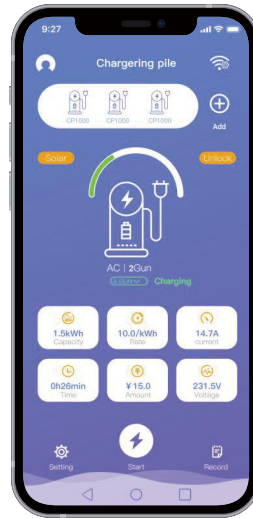

Model	ZECO7K-S1	ZECO11K-S2	ZECO22K-S3
<b>Technical features</b>			
Charging capacity	Up to 7KW	Up to 11 KW	Up to 22KW
Input/Output power	230VAC±20%-50/60Hz-32A-1phase	400VAC±20%-50/60Hz-16A-3phase	400VAC±20%-50/60Hz-32A-3phase
RCD	30Ma RCD Type A and DC 6Ma RCD function or Type B(optional)		
Standby power	<3W		
Measuring accuracy	1%		
Energy Meter	MID certified		
OCPP	OCPP1.6 Json(OCPP2.0 optional)		
Communication	WIFI / Ethernet / 4G(Optional)		
User interface	LED / LCD(3.5") / RFID(mifare iso& IEC 14443A)		
Certificate/Compliance	CE / EN/IEC 61851-1:2017, EN/IEC 61851-21-2:2018		
Charging Interface	Type 2 socket / 5M Cable		
Special Protection	Over current protection, Residual current protection, Ground protection, Surge protection, Over/Under voltage protection, Over/Under frequency protection, Over/Under temperature protection		
<b>Physical properties</b>			
Warranty	2 years		
Protection	IP54, IK10,		
Enclosure	Plastic PC940/ Galvanized steel		
Front Panel	Temper glass		
Installation	Wall-mount/Pole-mount		
Cooling	Natural cooling		
Operating temperature	-30°C to +55°C		
Humidity	Max.95%(non-regulating)		
Product Dimensions	320*230*100(L*W*H)mm		
Package Dimension	465*325*270(L*W*H)mm		
Net Weight	5.1Kg	5.5Kg	5.5Kg
Gross Weight	5.8Kg	6.2Kg	6.5Kg

# Pro EV Wallbox with cable & socket

## Safe and Fast

OCPP(1.6 above) communication protocol with CMS  
Wireless communication Bluetooth/Wi-Fi/Ethernet/4G optional

## Simple and intelligent

MID certified energy meter with accurate measurement  
Type A+DC 6mA leakage protection  
Support IP65 waterproof level

## Flexible Option

Home and Public, cable and socket, Type 2 and Lever 2



Model	ZECO7K-P1	ZECO11K-P2	ZECO22K-P3
<b>Technical features</b>			
Charging capacity	Up to 7KW	Up to 11 KW	Up to 22KW
Input/Output power	240VAC±20%-50/60Hz-32A-1phase	400VAC±20%-50/60Hz-16A-3phase 240VAC±20%-50/60Hz-40A-1phase (optional)	400VAC±20%-50/60Hz-32A-3phase 240VAC±20%-50/60Hz-40A-1phase (optional)
RCD	30Ma RCD Type A and DC 6Ma RCD function or Type B(optional)		
Standby power	<3W		
Measuring accuracy	1%		
Energy Meter	MID certified		
Load balancing	CT+Meter(Optional)		
PEN Protection	Optional		
OCPP	OCPP1.6 Json(OCPP2.0 optional)		
Communication	Bluetooth/WIFI/Ethernet/4G(Optional)		
User interface	LED / LCD(3.5") / RFID(mifare iso& IEC 14443A)		
Input Plug	NEMA 14-50(Optional)		
Certificate/Compliance	CE / EN/IEC 61851-1:2019, EN/IEC 61851-21-2:2018/ NEC 625, SAE J1772, UL 817, UL 991, UL 2231, UL 225, and UL 2594.		
Charging Interface	Type 2 socket/ 5M Cable SAE J1772 32A 5M (optional)	Type 2 socket/ 5M Cable SAE J1772 40A 5M (optional)	Type 2 socket/ 5M Cable SAE J1772 48A 5M (optional)
Special Protection	Over current protection, Residual current protection, Ground protection, Surge protection, Over/Under voltage protection, Over/Under frequency protection, Over/Under temperature protection		
<b>Physical properties</b>			
Warranty	2 years		
Protection	IP65, IK10,		
Enclosure	Plastic PC940/ Galvanized steel		
Front Panel	Temper glass		
Installation	Wall-mount/Pole-mount		
Cooling	Natural cooling		
Operating temperature	-30°C to +55°C		
Humidity	Max.95%(non-regulating)		
Product Dimensions	320*230*100(L*W*H)mm		
Package Dimension	465*325*270(L*W*H)mm		
Net Weight	5.5Kg	5.8Kg	6.1Kg
Gross Weight	6.2Kg	6.5Kg	6.8Kg

# Twin Pedestal Wallbox Series

## Innovativeness

One charger with two output sockets  
Business use with intelligent App control  
Vandal resistant and anti-corrosion

## Intelligent Control

Ethernet/4G/Wi-Fi communication all supported  
OCPP communication protocol with CMS ent  
Intelligent operation by App and cashless payment

## Flexible Option

App operation or RFID authentication or plug and play  
Customization with different color painting



Model	ZECO14K-T1	ZECO22K-T2	ZECO44K-T3
<b>Technical features</b>			
Charging capacity	Up to 14KW(7KW*2)	Up to 22KW(11KW*2)	Up to 44KW(22KW*2)
Input/Output power	230VAC±20%-50/60Hz-32A*2-1phase	400VAC±20%-50/60Hz-16A*2-3phase	400VAC±20%-50/60Hz-32A*2-3phase
RCD	RCMU(Type A+ DC 6mA)/ Type B RCCB(Optional).		
Standby power	<5W		
Measuring accuracy	1%		
Energy Meter	MID certified		
OCPP	OCPP1.6 Json(OCPP2.0 optional)		
Communication	WIFI/Ethernet/4G(Optional)		
User interface	LCD 5 inch Touch Screen/ RFID(mifare iso& IEC 14443A)		
Certificate/Compliance	CE/FCC/ROHS/REACH/IEC/EN 61851-1 , IEC/EN61851-21-2, IEC/EN 62955, EN300328, EN 301489-1/-17,EN62479.		
Charging Interface	Type 2 socket*2 or Type 2 Gun *2 5M		
Special Protection	Over current protection, Residual current protection, Ground protection, Surge protection, Over/Under voltage protection, Over/Under frequency protection, Over/Under temperature protection		
<b>Physical properties</b>			
Warranty	2 years		
Protection	IP65, IK10,		
Enclosure	Galvanized steel		
Front Panel	Temper glass		
Installation	Wall-mount/Pole-mount.		
Cooling	Natural cooling		
Operating temperature	-30°C to +55°C		
Humidity	Max.95%(non-regulating)		
Product Dimensions	503*334*155(L*W*H)mm		
Package Dimension	610*415*250(L*W*H)mm		
Net Weight	13.5Kg	13.5Kg	13.5Kg
Gross Weight	15Kg	15Kg	15Kg

# Twin Pedestal Series

## Safe and Fast

One charger with two output sockets  
Business use with intelligent App control  
Vandal resistant and anti-corrosion

## Simple and intelligent

Ethernet/4G/Wi-Fi communication all supported  
OCPP communication protocol with CMS  
Intelligent operation by App and cashless payment

## Flexible Option

App operation or RFID authentication or plug and play  
Customization with different color painting



Model	ZECO14K-BK1	ZECO22K-BK2	ZECO44K-BK3
<b>Technical features</b>			
Charging capacity	Up to 14KW(7KW*2)	Up to 22KW(11KW*2)	Up to 44KW(22KW*2)
Input/Output power	230VAC±20%-50/60Hz-32A*2-1phase	400VAC±20%-50/60Hz-16A*2-3phase	400VAC±20%-50/60Hz-32A*2-3phase
RCD	30Ma RCD Type A and DC 6Ma RCD function or Type B(optional)		
Standby power	<5W		
Measuring accuracy	1%		
Energy Meter	MID certified		
OCPP	OCPP1.6 Json(OCPP2.0 optional)		
Communication	WIFI/Ethernet/4G(Optional)		
User interface	LED / LCD(3.5") / RFID(mifare iso& IEC 14443A)		
Certificate/Compliance	CE / EN/IEC 61851-1:2017, EN/IEC 61851-21-2:2018		
Charging Interface	Type 2 socket*2 or Type 2 Gun *2 5M		
Special Protection	Over current protection, Residual current protection, Ground protection, Surge protection, Over/Under voltage protection, Over/Under frequency protection, Over/Under temperature protection		
<b>Physical properties</b>			
Warranty	2 years		
Protection	IP54, IK10,		
Enclosure	Galvanized steel		
Front Panel	Temper glass		
Installation	Floor-stand		
Cooling	Natural cooling		
Operating temperature	-30°C to +55°C		
Humidity	Max.95%(non-regulating)		
Product Dimensions	1200*290*230(L*W*H)mm		
Package Dimension	1320*480*430(L*W*H)mm		
Net Weight	30Kg	33Kg	35Kg
Gross Weight	45Kg	48Kg	50Kg

# Advertising pedestal series

## Innovativeness

One charger with two output sockets  
Business use with intelligent App control  
Vandal resistant and anti-corrosion

## Intelligent Control

Ethernet/4G/Wi-Fi communication all supported  
OCPP communication protocol with CMS  
Intelligent operation by App and cashless payment

## Large screen advertising revenue

55"IPS 2500cd/m<sup>2</sup>  
Remotely update AD content



Model	ZECO14K-AD1	ZECO22K-AD2	ZECO44K-AD3
<b>Technical features</b>			
Charging capacity	Up to 14KW(7KW*2)	Up to 22KW(11KW*2)	Up to 44KW(22KW*2)
Input/Output power	230VAC±20%-50/60Hz-32A*2-1phase	400VAC±20%-50/60Hz-16A*2-3phase	400VAC±20%-50/60Hz-32A*2-3phase
RCD	RCMU(Type A+ DC 6mA)/ Type B RCCB(Optional)		
Standby power	<5W		
Measuring accuracy	1%		
Energy Meter	MID certified		
OCPP	OCPP1.6 Json(OCPP2.0 optional)		
Communication	WIFI/Ethernet/4G(Optional)		
User interface	LCD 5 inch Touch Screen/ RFID(mifare iso& IEC 14443A)		
Certificate/Compliance	CE/FCC/ROHS/REACH/IEC/EN 61851-1 , IEC/EN61851-21-2, IEC/EN 62955, EN300328, EN 301489-1/-17,EN62479.		
Charging Interface	Type 2 socket*2 or Type 2 Gun *2 5M		
Special Protection	Over current protection, Residual current protection, Ground protection, Surge protection, Over/Under voltage protection, Over/Under frequency protection, Over/Under temperature protection		
<b>Advertising display</b>			
LCD screen	55"IPS 1920*1080 16:9 HDV 2500cd/m <sup>2</sup>		
Application platform	Android 4.3 and above		
Communication	WIFI/Ethernet/4G(Optional)		
Ad update	USB flash disk,SD card, wired network remote release		
<b>Physical properties</b>			
Warranty	2 years		
Protection	IP55(outdoor)		
Special Protection	Topple & fall down protection		
Cooling	Natural cooling		
Operating temperature	-20°C to +55°C		
Humidity	Max.95%(non-regulating)		
Product Dimension	1950*920*290mm(L*W*H)		
Package Dimension	2110*450*1170mm(L*W*H)		
Net Weight	145kg		
GrossWeight.	201Kg		

# MINI DC Series

20KW-30KW-40KW the best charging station  
For EV fast charger

## Friendly interface

7-inch touch screen LCD and ring LED offer good user display requirements for charging.

## Simple control

It is easy to control on and off through the Bluetooth function of the mobile phone APP and RFID function.

## Fast and Safety

40KW CCS type 2 plug, more efficient charging  
IP54 protection level for outdoor installation.

## Wide application

Compliant with OCPP 1.6 and above enables it to connect to the global EV charge management platform without additional integration and matching.



Model	ZECO30K-D1	ZECO40K-D2	ZECO60K-D3
<b>Technical features</b>			
Max Power	Up to 30KW	Up to 40KW	Up to 60KW
Input/Output power	400VAC±10%-50/60Hz-3phase	400VAC±10%-50/60Hz-3phase	400VAC±10%-50/60Hz-3phase
Power factor	0.98		
Efficiency	>95%		
Measuring accuracy	Level 0.5		
Output voltage range	CCS: 300~1000VDC		
Output current range	0-100A	0-100A*2	0-200A*2
Communication	Ethernet/WIFI/4G/OCPP 1.6 Json (OCPP 2.0 optional)		
User interface	RFID card and APP		
Display	LCD 7 inch Touch Screen		
Versatility	IEC61851/IEC62196/ISO1511/DIN70121/EN61000-6-4:2007		
Energy Meter	CE certified		
RCD	Type A or Type B(optional)		
Security design	Over/under voltage protection, overload protection, current leakage protection, grounding protection, lightning surge protection		
DC Plugs	CCS2 Cable 5M	CCS2*2 Cable 5M	CCS2*2 Cable 5M
<b>Physical properties</b>			
Warranty	2 years		
Application place	Indoor/Outdoor		
Installation method	Wall mount, pedestal mount (optional)		
Sound noise	<55DB in all directions		
Operating temperature	-20 C to +50 C		
Humidity	Max.95%(non-regulating)		
Dimensions	670*460*270mm	770*560*206mm	900*650*260mm
Package Dimension	800*590*480mm	1010*720*510mm	1200*920*450mm
Net Weight	41Kg	75Kg	115Kg
Gross Weight	46Kg	78Kg	120Kg

# Super DC Series

90-150KW the best charging station  
For EV fast charger

## High Efficiency

One charger with two outputs, simultaneously charging  
Two CCS2 DC connectors, with output up to 150kW  
Constant power from 250~1000V voltage, less heat with  
smaller current

## Intelligent Control

Ethernet/4G/Wi-Fi communication all supported  
OCPP1.6 communication protocol with CMS  
Intelligent operation by App and cashless payment

## Flexible Option

One charger with two outputs, simultaneously charging  
Two CCS2 DC connectors, with output up to 150kW  
Constant power from 250~1000V voltage, less heat with  
smaller current

## Secure and Safe

Type A RCD for residual current protection  
PTB certified energy meter with accurate measurement  
ISO15118 prepared for advanced feature of Plug&Charge



Model	ZECO90K-D4	ZECO120K-D5	ZECO150K-D6
<b>Technical features</b>			
Max Power	Up to 90KW	Up to 120KW	Up to 150KW
Input/Output power	400VAC±10%-50/60Hz-3phase	400VAC±10%-50/60Hz-3phase	400VAC±10%-50/60Hz-3phase
Power factor	≥0.98		
Efficiency	>95%		
Measuring accuracy	Level 0.5		
Output voltage range	CCS: 250~1000VDC		
Output current range	0-165A	0-200A	0-250A
Communication	PLC (between charger & vehicle) Ethernet/4G/Wifi/OCPP 1.6J(optional)		
User interface	LCD 7 inch Touch Screen / RFID card and APP		
Versatility	EN/IEC 61851-1: 2019, EN/IEC 61851-23: 2014		
Security design	Over/under voltage protection, overload protection, current leakage protection, grounding protection,lightening surge protection		
DC Plugs	CCS 2Plugs 7M or 10M(Optional)		
Energy Meter	PTB certified		
RCD	Type A or Type B(optional)		
<b>Physical properties</b>			
Warranty	2 years		
Cooling	Air cooled		
IP Level	IP54		
Sound noise	<70DB in all directions		
Operating temperature	-20°C to +50°C		
Humidity	Max.95%(non-regulating)		
Product Dimensions	750*770*1900mm		
Package Dimension	800*850*2000(L*W*H)mm Wooden packing		

# DC Advertising pedestal series

## Innovativeness

One charger with two output sockets  
Business use with intelligent App control  
Vandal resistant and anti-corrosion

## Intelligent Control

Ethernet/4G/Wi-Fi communication all supported  
OCPP communication protocol with CMS  
Intelligent operation by App and cashless payment

## Large screen advertising revenue

55"HDV 3500cd/m<sup>2</sup>  
Remotely update AD content



Model	ZECO60K-ADD4	ZECO120K-ADD5
<b>Technical Features</b>		
Charging Capacity	Up to 60KW	Up to 120KW
Input / Output Power	400VAC±10%-50/60Hz- 3phase	
Power Factor	≥0.98	
Efficiency	>95%	
Measuring Accuracy	level 0.5	
Output Voltage Range	CCS: 250~1000VDC	
Output Current Range	0-180A	0-250A
Communication	PLC (between charger & vehicle) Ethernet / 4G / OCPP 1.6J (Optional)	
User Interface	LCD 7 inch Touch Screen / RFID card and APP	
Versatility	EN / IEC 61851-1: 2019, EN / IEC 61851-23: 2014.	
Security Design	Over / under voltage protection, overload protection, current leakage protection, grounding protection, lightning surge protection	
DC Plugs	CCS2 Cable 5M*2.	
Energy Meter	CE certified or PTB (Optional)	
RCD	Type A or Type B (Optional)	
<b>Advertising Display</b>		
Mainboard	Android Based Quad-core	
RAM	2GB	
Storage	8GB, can extend to 32GB	
Video Format	MPG, MPG-1, MPG-2, MPG-4, AVI, MP4, TS, MKV, WMV	
Maximum Decoding Resolution	3480*2160	
Picture Format	GIF, JPEG, PNG, BMP	
Audio Output	2x10W	
Audio Format	MP3, 24bit linear PCM7.1	
Other Format	PDF / RSS, News / Weather-Forecast	
Network	Rj45 interface, Wifi, 4G, Option,	
The Update Way For Content	Network remote update, U disk update.	
Display Mode	Landscape / Portrait, Full Screen / Any Split Screen	
Program Upgrade	Remote upgrade, remote upgrade	
Timer Switch	Support any time period	
<b>Panel Parameters</b>	Panel Type	55 Inch LCD Panel
	Display area	1209*680mm
	Display ratio	16:9
	Backlight type	LED backlight
	Resolution	3480x2160
	Display color	16.7M
	Brightness	3500-cd/m <sup>2</sup>
	Contrast	3500:1
	View angle	178°(H) / 178°(V)
	Response time	6ms
Life time	50000 hours	
<b>Physical Properties</b>		
Warranty	3 years	
Protection	IP55 (Outdoor)	
Special Protection	Topple & fall down protection	
Cooling	Natural cooling	
Operating Temperature	-30°C to +55°C	
Humidity	Max.95% (Non-Regulating)	
Dimensions	2310*1170*650 (L*W*H)	
Net Weight	280Kg	
Gross Weight	321Kg	



# Super DC Series

120-240KW the best charging station  
For EV fast charger

## High Efficiency

One charger with two outputs, simultaneously charging  
Two CCS2 DC connectors, with output up to 240kW  
Constant power from 250~1000V voltage, less heat with  
smaller current

## Intelligent Control

Ethernet / 4G / communication all supported  
OCPP1.6 communication protocol with CMS  
Intelligent operation by App and cashless payment

## Flexible Option

App operation or RFID authentication or plug and play  
High protection grade as IP54, with IP65 optional  
Optional POS terminal for contactless credit card  
payment

## Secure and Safe

Type A RCD for residual current protection  
PTB certified energy meter with accurate measurement  
ISO15118 prepared for advanced feature of Plug & Charge



Model	ZECO120K-D7	ZECO160K-D7	ZECO180K-D7	ZECO240K-D7
<b>Technical features</b>				
Max Power	Up to 120KW	Up to 150KW	Up to 180KW	Up to 240KW
Input / Output Power	400VAC±10%-50/60Hz-3phase	400VAC±10%-50/60Hz-3phase	400VAC±10%-50/60Hz-3phase	400VAC±10%-50/60Hz-3phase
Power factor	≥0.98			
Efficiency	>95%			
Measuring Accuracy	Level 0.5			
Output Voltage Range	CCS: 250~1000VDC			
Output Current Range	0-250A	0-250A	0-250A	0-250A
Communication	PLC (between charger & vehicle) Ethernet / 4G / OCPP 1.6J (Optional)			
User Interface	LCD 7 Inch Touch Screen / RFID Card and APP			
Versatility	EN / IEC 61851-1: 2019, EN / IEC 61851-23: 2014			
Security Design	Over/under voltage protection, overload protection, current leakage protection, grounding protection, lightening surge protection			
DC Plugs	CCS2 Cable 5M or 7M (Optional)			
Energy Meter	CE Certified			
RCD	ype A or Type B (Optional)			
<b>Physical Properties</b>				
Warranty	2 Years			
Cooling	Air Cooled			
IP Level	IP54			
Sound Noise	<70DB in all Directions			
Operating Temperature	-20°C to +50°C			
Humidity	Max.95% (Non-Regulating)			
Dimensions	750*770*1900mm			
Package Dimension	800*850*2000 (L*W*H) mm Wooden Packing			

# Super DC Series

120-240KW the best charging station  
For EV fast charger

## High Efficiency

One charger with two outputs, simultaneously charging  
Two CCS2 DC connectors, with output up to 240kW  
Constant power from 250~1000V voltage, less heat with  
smaller current

## Intelligent Control

Ethernet / 4G / communication all supported  
OCPP1.6 communication protocol with CMS  
Intelligent operation by App and cashless payment

## Flexible Option

App operation or RFID authentication or plug and play  
High protection grade as IP54, with IP65 optional  
Optional POS terminal for contactless credit card  
payment

## Secure and Safe

Type A RCD for residual current protection  
PTB certified energy meter with accurate measurement  
ISO15118 prepared for advanced feature of Plug & Charge



Model	ZECO120K-D4	ZECO160K-D4	ZECO180K-D4	ZECO240K-D4
<b>Technical features</b>				
Max Power	Up to 120KW	Up to 150KW	Up to 180KW	Up to 240KW
Input / Output Power	400VAC±10%-50/60Hz-3phase			
Power Factor	≥0.98			
Efficiency	>95%			
Measuring Accuracy	Level 0.5			
Output Voltage Range	CCS: 250~1000VDC			
Output Current Range	0-250A	0-250A	0-250A	0-250A
Communication	PLC (between charger & vehicle) Ethernet / 4G / OCPP 1.6J (Optional)			
User Interface	LCD 7 Inch Touch Screen / RFID Card and APP			
Versatility	EN / IEC 61851-1: 2019, EN / IEC 61851-23: 2014			
Security Design	Over / under voltage protection, overload protection, current leakage protection, grounding protection, lightning surge protection			
DC Plugs	CCS2 Cable 5M or 7M (Optional)			
Energy Meter	CE certified			
RCD	Type A or Type B (Optional)			
<b>Physical Properties</b>				
Warranty	2 Years			
Cooling	Air Cooled			
IP Level	IP54			
Sound Noise	<70DB in all Directions			
Operating Temperature	-20°C to +50°C			
Humidity	Max.95% (Non-Regulating)			
Dimensions	750*770*1750mm			
Package Dimension	800*850*1950 (L*W*H) mm Wooden Packing			

# Cloud Platform

Dedicated to enabling the future of e-Mobility by providing the most open, secure and robust charging network anywhere. A charging platform based on the cloud server makes it simple for charger owners to operate and customize chargers to meet their specific requirements. We provide everything you need to offer a complete EV charging solution.

- ▶ **Management System:** A central system for charger operators manage charge points and monitor charging service. Status monitor, charger record, price management, firmware upgrade, remote diagnose, and load balance are offered in one capable system.
- ▶ **Mobile App:** A charging App for EV drivers who needs charging service. Price, locations, availability, start/stop charging, and auto billing are available in an easy way.
- ▶ **Interoperability:** Connections while e-Mobility Service Providers who have EV drivers as customers are viable through the open charge point interface protocol (OCPI)

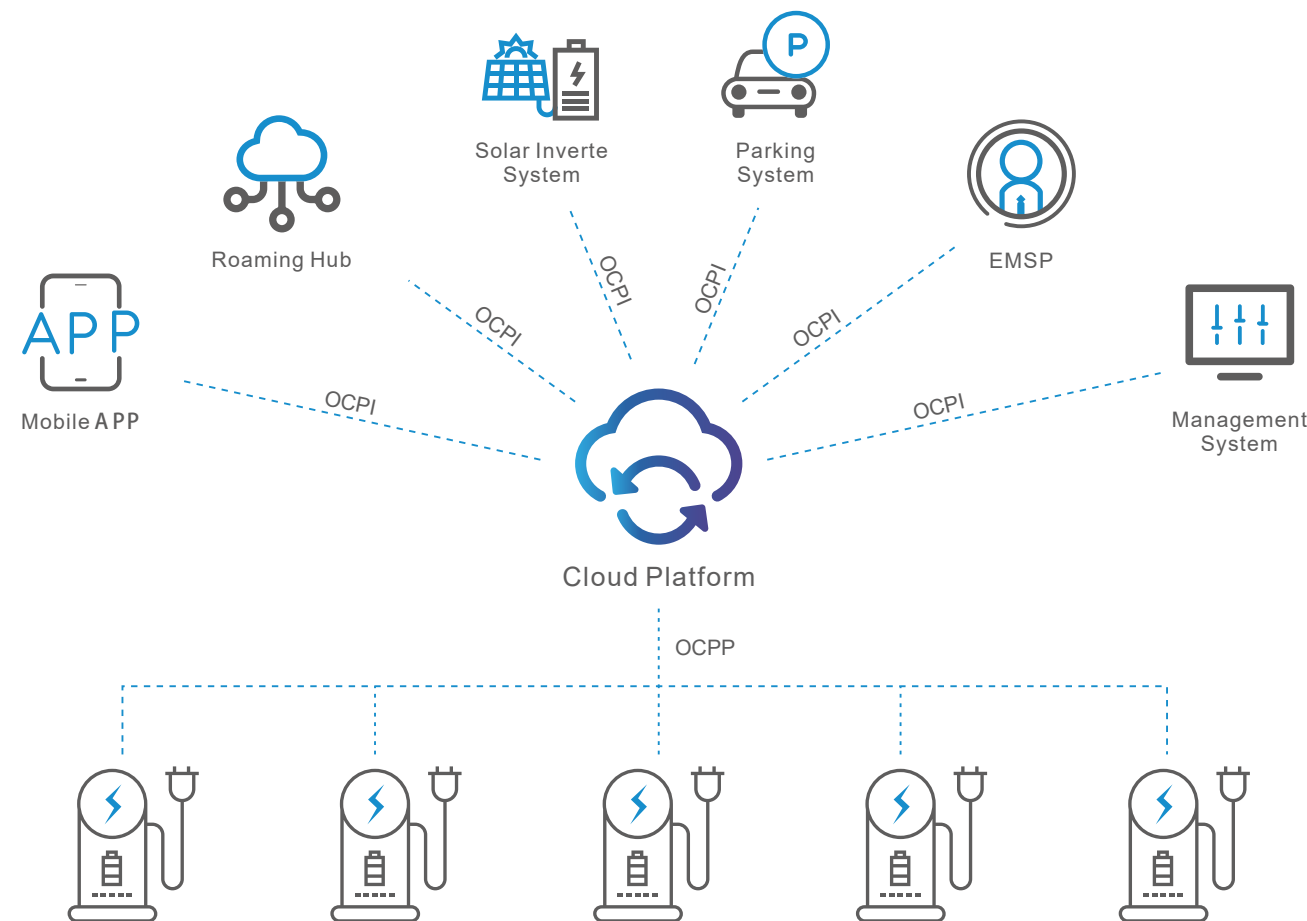

# Mobile APP



The charging App connects EV drivers with charging stations, so that they can easily find a charger and enjoy the charging service. It enables users to do location search, charging monitor and payment settlement. All is done in a mobile phone.

-   
**Account Signup**  
Easy signup with a mobile phone number
-   
**Location Search**  
Quick search for available charging facilities
-   
**Charging Operation**  
Friendly interface and convenient operation



-   
**Real Time Monitor**  
Real time presentation of charging consumption
-   
**Cashless Payment**  
Mobile payment from credit card, like Nets, PayWay
-   
**Auto Billing**  
Secure billing through registered account

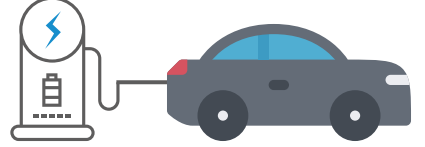

- 1 Download the App and sign up an account. 
- 2 Plug the charging cable into EV. 
- 3 Scan QR code to start charging. 
- 4 Stop charging in the App and settle payment automatically. 